

GTi SERIES

A6000GTi
A3000GTi

car audio
power amplifier
owner's manual



**THE OFFICIAL BRAND
OF LIVE MUSIC.**

THANK YOU

for purchasing a JBL A6000GTi or A3000GTi amplifier.
For warranty support, please register your purchase at www.jbl.com. Select Car Audio, then click on Product Support, and then click on Register...Online. Also, please retain your original purchase receipt and packing crate in case you must ship your unit back for service.



Designed and Engineered
in the USA

INSTALLATION

WARNING: Playing loud music in an automobile can hinder your ability to hear traffic and permanently damage your hearing. We recommend listening at low or moderate levels while driving your car. JBL accepts no liability for hearing loss, bodily injury or property damage resulting from the use or misuse of this product.

IMPORTANT: To get the best performance from your JBL A6000GTi or A3000GTi amplifier, we strongly recommend that installation be entrusted to a qualified professional. Although these instructions explain how to install JBL amplifiers in a general sense, they do not show specific installation methods that may be required for your particular vehicle. If you do not have the necessary tools or experience, do not attempt the installation yourself. Instead, please ask your authorized JBL car audio dealer about professional installation.

INSTALLATION WARNINGS AND TIPS

- Always wear protective eyewear when using tools.
- Turn off all audio components and other electrical devices before you start. Disconnect the (-) negative lead from your vehicle's battery.
- Check clearances on both sides of a planned mounting surface before drilling holes or installing screws. Remember – the screws can extend behind the surface.

- At the installation sites, locate and make a note of all fuel lines, hydraulic brake lines, vacuum lines, and electrical wiring. Use extreme caution when cutting or drilling in and around these areas.
- Before drilling or cutting holes, use a utility knife to remove unwanted fabric or vinyl to keep material from snagging in a drill bit.
- When routing cables, keep input-signal cables away from power cables and speaker wires. Use grommets when passing cables through the vehicle's inner walls.
- When making connections, observe the amplifier's polarity markings. Make sure that each connection is clean and properly secured. Use the shortest ground wire possible to minimize resistance and avoid noise problems.
- If the amplifier's fuse must be replaced, use only the same type and rating as that of the original. Do not substitute another kind.

CHOOSING A MOUNTING LOCATION

The JBL A6000GTi and A3000GTi amplifiers are big! Conventional mounting locations under driver or passenger seats will not accommodate either amplifier. Mount the amplifier in the vehicle's trunk or cargo area, but never mount the amplifier in the engine compartment, outside the vehicle or in any location where it may get wet. When choosing a location, make sure the site's underlying structure is strong enough to support the amplifier's weight and drilled holes for mounting bolts. Also, verify that there will be adequate ventilation around the amplifier, so that airflow to its internal fans will not be blocked and the unit can properly cool itself.

WARNING: To avoid personal injury and possible product damage, we strongly urge you to enlist additional help in unpacking and moving the JBL A6000GTi or A3000GTi amplifier to a desired mounting location.

PARTS LIST

Each amplifier is packed with the following parts:

- Four (4) 1/2" x 3" socket-head cap screws and T-nuts.
- One (1) Remote Level Control with mounting hardware
- One (1) 15' RJ11 Cable for Remote Level Control
- One (1) Logo Badge
- One (1) Set of Performance Graphs
- One (1) Owner's Manual
- One (1) Warranty Registration Instruction Card

MOUNTING THE AMPLIFIER

We strongly recommend first mounting a piece of wood or Medium Density Fiberboard (MDF) to the vehicle, and then mounting the amplifier to the board. The amplifier is large and heavy and must be mounted using all four screws and T-nuts provided. Using the amplifier as a template, mark the location of the mounting holes on the mounting surface, drill pilot holes, and securely attach the amplifier to the mounting surface with the provided screws and T-nuts. Make sure the amplifier does not pinch or smash power cables, speaker wires, input cables or any of the vehicle's wiring. Install the Remote Level Control in a convenient location in or under the dashboard. The control may be removed from its housing for custom installation. Using the enclosed RJ11 cable, connect the control to the amplifier, as shown in Figure 1.

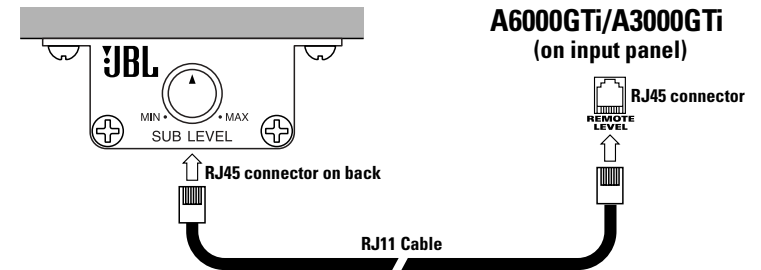

Figure 1. Connecting the Remote Level Control.

Once the amplifier is mounted, peel the backing from the adhesive (on the back of the logo badge) and attach the badge in the appropriate orientation.

DESIGNING A SPEAKER SYSTEM FOR THE GTi AMPLIFIER

NOTE: Although the JBL A6000GTi or A3000GTi amplifier will drive a system made up of any subwoofers, we recommend using JBL GTi subwoofers with GTi amplifiers.

Both the JBL A6000GTi and A3000GTi amplifiers provide RMS power that exceeds the RMS power-handling rating of nearly every subwoofer available. To use this amplifier optimally, you should design a speaker system made up of several identical speakers, so that the power delivered by the amplifier will be shared equally among the speakers.

The JBL A6000GTi and A3000GTi amplifiers support a wide range of impedances, and any speaker system with a total or equivalent impedance of 1 to 4 ohms will extract full power from either amplifier. In order to connect multiple woofers to the A6000GTi or A3000GTi, you'll need to connect your speakers in series, parallel or series-parallel. We've included diagrams for each connection scheme and a pair of formulas, which will help you.

SERIES CONNECTIONS

The formula for determining the total impedance of the two woofers connected in series is:

$$Z_{\text{total}} = Z_1 + Z_2 + Z_3 \dots$$

Where Z_{total} is the total impedance of all woofers connected in series. Z_1 , Z_2 and Z_3 (and so on) are the nominal impedance ratings of the individual speakers. The total impedance of the voice coils shown in Figure 2 is 8 ohms.

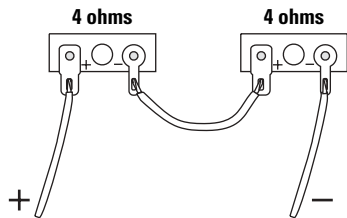

Figure 2. Series connection of two 4-ohm voice coils yields a total impedance of 8 ohms.

PARALLEL CONNECTIONS

The formula for determining the equivalent impedance of the voice coils connected in parallel is:

$$Z_{\text{equivalent}} = 1/(1/Z_1 + 1/Z_2 + 1/Z_3 \dots)$$

Where $Z_{\text{equivalent}}$ is the equivalent impedance of the coils connected in parallel. Z_1 , Z_2 and Z_3 (and so on) are the nominal impedance ratings of the individual speakers. The equivalent impedance of the voice coils shown in Figure 3 is 2 ohms.

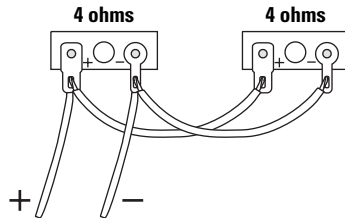
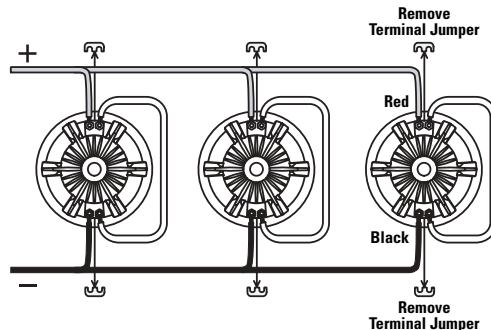

Figure 3. Parallel connection of two 4-ohm voice coils yields a total impedance of 2 ohms.

DUAL VOICE-COIL CONNECTIONS

Dual voice-coil subwoofers, such as JBL's GTi series, may be connected in series, as shown in Figure 2; in parallel, as shown in Figure 3; or in series-parallel, as shown in Figure 4.

Figure 4. Series-parallel connections of three W15GTi subwoofers (with a voice coil impedance of 6 ohms) yields a total series impedance of 12 ohms for each subwoofer, and an equivalent parallel impedance of 4 ohms for all three subwoofers.



To determine the impedance of a system of three W15GTi (dual voice-coil) subwoofers connected in series-parallel, use the series connection formula to determine the impedance of each subwoofer with its voice coils connected in series. Then insert the calculated value into the parallel connection formula to determine the equivalent impedance for the three subwoofers connected in parallel.

NOTE: Each W15GTi voice coil has an impedance of 6 ohms.

For example, in Figure 4, each woofer will have an impedance of 12 ohms, by

$$Z_{\text{total}} = Z_1 + Z_2 = 6 + 6 = 12$$

and the three woofers connected in parallel will have an equivalent impedance of 4 ohms, by

$$\begin{aligned} Z_{\text{equivalent}} &= 1/(1/Z_1 + 1/Z_2 + 1/Z_3) \\ &= 1/(1/12 + 1/12 + 1/12) \\ &= 1/(3/12) \\ &= 12/3 = 4 \end{aligned}$$

NOTE: All subwoofers connected to an amplifier in a system must be identical and, if they are dual voice-coil subwoofers, their coils must be wired identically. Do not connect the coils of one subwoofer together in series and another in parallel, since doing so will cause uneven power distribution, potential damage to the speakers, and poor overall performance.

ABOUT SPEAKER POWER HANDLING

The RMS power handling rating of a speaker indicates the amount of power it will handle continuously. Although designing a subwoofer system by considering the RMS rating will ultimately provide you with the most reliable system, your speakers may be able to handle more power, depending on what kind of music is being reproduced.

For music with extended bass notes (e.g., bass music, hip-hop or techno), you should design a speaker system based on the RMS power handling of your speakers. For music with sharp transient bass notes (e.g., rock, country or jazz), the RMS power handling rating is conservative, and you can count on your speakers being able to handle more power than the RMS rating.

The total power output of your amplifier will be divided among the speakers connected to it. For example, if you are using an A6000GTi and three W15GTi subwoofers, each subwoofer will receive 2,000 watts.

It's important to choose a system of subwoofers that will handle all of the power. To determine how much total power your speaker system will handle, simply multiply the RMS power handling rating of one of your speakers by the total number of speakers that will be connected.

SUPPLYING POWER TO THE GTi AMPLIFIER

POWER IN IS POWER OUT

In order to get full power out of your amplifier, you must provide full power to your amplifier. That's a basic rule of physics. The A6000GTi amplifier can draw nearly 800 amperes when reproducing sine waves at full output. Both JBL A6000GTi and A3000GTi amplifiers can quickly exhaust the factory-installed charging system of any vehicle on the road today. With this much available amplifier power, you will need to beef up your vehicle's electrical system to satisfy the amplifier's current demands. We recommend adding at least two 12-volt batteries, connected in parallel with cold-cranking capacities of at least 600 amperes each, to the factory-installed charging system.

HOW YOUR CHARGING SYSTEM WORKS

The battery's job is to start your vehicle. Running the electrical accessories is the alternator's job. The battery isn't designed to be a continuous source of power. It is a renewable source and is charged by the alternator when the engine runs. Battery charging can only occur when the current demand from the electrical accessories is less than the total current output capacity of the alternator.

PROGRAM MATERIAL AND CURRENT DEMAND

Music is a combination of loud and soft sounds, with varying durations and rhythms that present unique current demands during amplification. For example, it may take full power to reproduce the sound of a kick drum. The peak power demand doesn't last very long, but it is repeated over and over.

If your charging system can't provide all the power your amplifier needs on a continuous basis, it still may be adequate. During the sound of the kick drum, the battery can provide the extra current that's necessary, and between kick drum beats, the alternator will put some of the energy back into the battery.

However, depending on the current rating of the alternator, the amplifier's maximum output power, the music content, and the charging system's capability, the alternator may not be able to keep up over time. In that case, you'll need to install a somewhat larger alternator for more current, or adjust your driving and listening habits, to give the alternator time to catch up with the amplifier's current demand.

Few stock batteries can provide the current required to reproduce even short-duration musical peaks. Adding a pair of batteries with cold-cranking capacities of 600 amperes will provide extra current for short music bursts, but reserve power may still be depleted over longer music intervals. Adding more batteries will provide more reserve power and current, but no matter how many are installed, the alternator will still have to recharge them all.

If you plan to use the A6000GTi or A3000GTi in SPL competition, the charging system requirements will be much greater than those for normal music listening. Be prepared to add additional batteries *and* alternators to provide continuous current required for continuous duty.

See your authorized JBL car audio dealer for help in designing and installing an upgraded charging system to support your GTi amplifier.

MAKING THE CONNECTIONS

POWER CONNECTIONS

Use 0-gauge cable to connect the amplifier's GND – terminal directly to the vehicle's chassis (see Figure 5). Scrape off all paint from the metal area for a good, clean ground connection. Make sure the ground wire is as short as possible and is connected to metal on the vehicle's body. Do not connect the GND – cable to the frame of the vehicle. It is isolated from the chassis using rubber shims and will not provide an adequate ground. Instead, use the trunk's floor or cargo area as a suitable location. Do not connect the GND – cable to the battery's negative (–) terminal.

Connect the source unit's remote turn-on lead to the REMOTE terminal on the amplifier (see Figure 5). Use any convenient gauge wire for the connection.

The amplifier's internal neon lights require a separate switched power connection with at least a 2-ampere current capacity. If desired, install a switch to turn on the neon lights or a relay triggered by a circuit in the vehicle (e.g., door switch, trunk pin switch or other turn-on source). If you want the amplifier's neon to light when the amplifier is on, connect the LIGHTING terminal to a relay triggered by the radio's remote turn-on lead (see Figure 5).

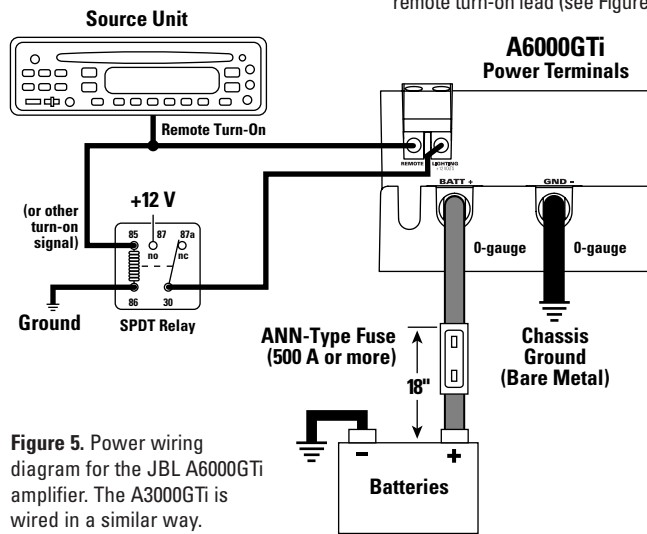

Figure 5. Power wiring diagram for the JBL A6000GTi amplifier. The A3000GTi is wired in a similar way.

Use 0-gauge cable to connect the BATT+ terminal directly to the vehicle's battery. If the battery is located in the engine compartment and the BATT+ cable must be routed through the firewall or any metal obstruction, install a wafer-type (ANN) fuse with a current rating of at least 500 amperes and an appropriate fuse holder within 18" of the vehicle's battery (see Figure 5).

IMPORTANT: Do not connect a jumper directly between the REMOTE and LIGHTING terminals. Doing so may burn out the remote turn-on circuits in your source unit.

SIGNAL CONNECTIONS

Use high-quality twisted-pair RCA audio cables to connect your source unit's main stereo or subwoofer RCA output jacks to the amplifier's L/R INPUT jacks. For a single subwoofer output, use an RCA "Y" adapter to connect its signal to both input jacks.

As a convenience, each JBL A6000GTi or A3000GTi amplifier is also equipped with a set of PASS-THRU L/R RCA audio jacks. They will pass incoming audio signals unaltered, and you can use them to send stereo audio signals to other components in your system.

REMOTE LEVEL CONTROL/ACCESSORY GAUGE OUTPUTS

The A6000GTi and A3000GTi use an RJ45 connector to output control signals for the Remote Level Control and accessory gauges. Use the 15' RJ11 cable to connect the control to the amplifier. For accessory gauges, use the pinouts in Figure 6 to make custom cables with materials found at most electronics supply stores or home centers.

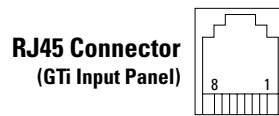

Figure 6. Pinouts for the REMOTE LEVEL RJ45 connector on the A6000GTi or A3000GTi amplifier.

For gauges, varying voltages are output on selected RJ45 pins to indicate voltage, current and temperature.

For battery voltage, linear scale (pin 1):

- 2 volts = 8 volts at the battery
- 4.5 volts = 18 volts at the battery

For temperature, linear scale (pin 2):

- 0 volts = –10 degrees Celsius
- 5 volts = 110 degrees Celsius

For current, linear scale (pin 3):

- 0 volts = 0 amperes current draw
- 5 volts = 800 amperes current draw

Also, you can connect a power meter using the pins for battery voltage and current. Be sure to use a power meter that multiplies the incoming voltage and current signals (i.e., $P = E \times I$) to convert the data to watts.

CONNECTING THE SPEAKERS

IMPORTANT: As a safety feature and due to the high output voltage capability of the A6000GTi and A3000GTi amplifiers, the SPEAKER OUTPUTS are equipped with a cover that must be in place in order for the amplifier to operate. When the cover is removed, the amplifier will turn off and speaker connections can be made safely.

MAKING THE CONNECTIONS

A6000GTi SPEAKER CONNECTIONS

The A6000GTi is a 2-channel amplifier designed to drive subwoofers only. The left and right input signals are combined inside the amplifier to provide a mono output signal, no matter which output mode is selected.

The A6000GTi can be connected to two independent speaker systems in 2-channel mode. It can be connected to a combination of subwoofers configured as a single load with its channels bridged or connected in parallel. Bridged channels will provide high output voltage for driving loads with a nominal impedance of 2 to 4 ohms. Connecting the channels in parallel will provide the high current necessary to drive loads of 1 to 2 ohms.

Included below are three application diagrams that will help you plan your A6000GTi installation. Figures 7 through 9 show how to configure the JBL A6000GTi subwoofer amplifier for bridged-mono, parallel-mono and 2-channel operation (see Setting Up the GTi Amplifier).

IMPORTANT: If the nominal impedance of the speaker system is close to 2 ohms, you may try both bridged and parallel configurations to determine which one performs better. Remember to set the output mode switch to the appropriate setting when changing configurations.

NOTE: For simplicity, Figures 7 through 9 do not show power, remote and input connections (see page 5).

Figure 7. The JBL A6000GTi subwoofer amplifier is set to bridged mode to drive a subwoofer system. Only use this mode when the nominal equivalent or total impedance of the speaker system is 2 ohms or greater.

Figure 8. The JBL A6000GTi subwoofer amplifier is set to parallel mode to drive a subwoofer system. Only use this mode when the nominal equivalent or total impedance of the speaker system is less than 2 ohms.

NOTE: A jumper is added between the + terminals.

Figure 9. The JBL A6000GTi subwoofer amplifier is set to 2-channel mode to drive a pair of subwoofers or subwoofer systems with nominal equivalent or total impedances of 2 to 4 ohms.

Set Output Mode to 2CH/BR
(on input panel)

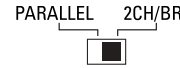

See "Setting The Crossover" on Page 8 to Adjust Crossover Controls

A6000GTi Amplifier
(partial output panel)

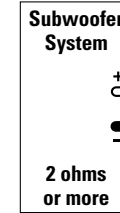
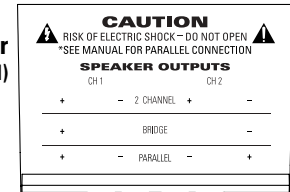

Set Output Mode to PARALLEL
(on input panel)

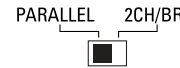

See "Setting The Crossover" on Page 8 to Adjust Crossover Controls

A6000GTi Amplifier
(partial output panel)

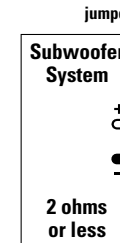
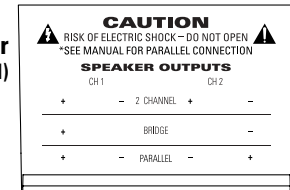

Set Output Mode to 2CH/BR
(on input panel)

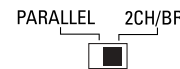

See "Setting The Crossover" on Page 8 to Adjust Crossover Controls

A6000GTi Amplifier
(partial output panel)

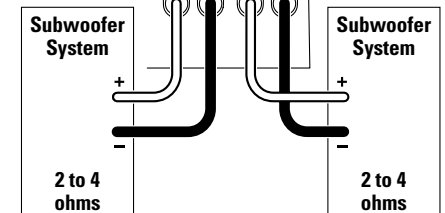
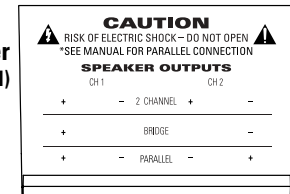

MAKING THE CONNECTIONS

A3000GTi SPEAKER CONNECTIONS

Included below are three application diagrams that will help you plan your A3000GTi installation. Figures 10 through 12 show how to configure the JBL A3000GTi amplifier for bridged-mono, parallel-mono and 2-channel operation (also see Setting Up the GTi Amplifier).

NOTE: For simplicity, Figures 10 through 12 do not show power, remote and input connections (see page 5).

Figure 10. The JBL A3000GTi amplifier is set to bridged mode to drive a subwoofer system. Only use this mode when the nominal equivalent or total impedance of the speaker system is 2 ohms or greater.

Set Output Mode to BRIDGE
(on input panel)



See "Setting The Crossover" on Page 8 to Adjust Crossover Controls

A3000GTi Amplifier (partial output panel)

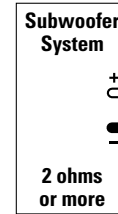
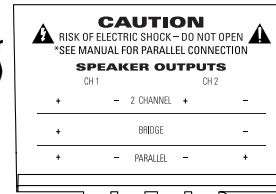

Figure 11. The JBL A3000GTi amplifier is set to parallel mode to drive a subwoofer system. Only use this mode when the nominal equivalent or total impedance of the speaker system is less than 2 ohms.

Set Output Mode to PARALLEL
(on input panel)



See "Setting The Crossover" on Page 8 to Adjust Crossover Controls

A3000GTi Amplifier (partial output panel)

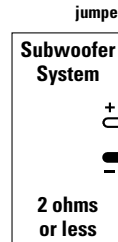
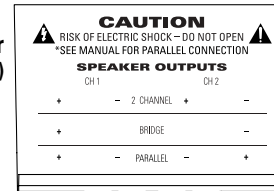

NOTE: A jumper is added between the + terminals.

Figure 12. The JBL A3000GTi amplifier is set to stereo mode to drive a pair of full-range speaker systems with nominal equivalent or total impedances of 2 to 4 ohms.

Set Output Mode to STEREO
(on input panel)



See "Setting The Crossover" on Page 8 to Adjust Crossover Controls

A3000GTi Amplifier (partial output panel)

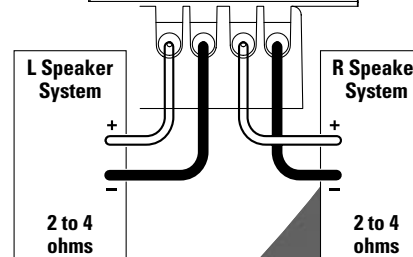
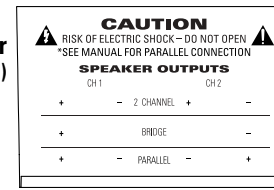

SETTING UP THE GTi AMPLIFIER

SETTING THE CROSSOVER

IMPORTANT: If you plan to use the A3000GTi to drive full-range speakers, set the crossover mode switch to FLAT and skip to the next section, "Setting Input Sensitivity."

1. Depending on your system plan, set the A3000GTi's crossover mode switch to LP (low-pass) or HP (high-pass). The A6000GTi is a low-pass amplifier only, designed to drive subwoofers. No crossover switch is provided.
2. The crossover slope has two settings: 12 (dB per octave) or 24 (dB per octave). Select the slope that best suits your taste, but consider that a steeper low-pass filter will make the subwoofers sound less directional (since more midrange will be filtered from the signal). A steeper high-pass filter will reduce a small speaker's unnecessary cone excursion at the lowest frequencies, which will increase power handling and reduce distortion.
3. Set the A3000GTi's HP FREQ control to allow the speakers to make as much bass as possible while minimizing distortion caused by small speakers trying to reproduce the lowest frequencies. The best setting is one where the speakers produce crisp, clear impact without being overdriven.
4. For either amplifier, set the LP FREQ control so vocal information is not reproduced by the subwoofers, and the subwoofers' sound blends with the sound of the midrange speakers without any missing information.

NOTE: The LP FREQ control can be set to any frequency between 32Hz and 320Hz.

SETTING INPUT SENSITIVITY

NOTE: You can use the supplied REMOTE LEVEL control to fine-tune the input sensitivity or to adjust the level of the bass according to the program material after the amplifier's LEVEL control has been set properly. Connect the remote module's attached cable to the REMOTE LEVEL (RJ45) jack on the amplifier's input panel. Start with the REMOTE LEVEL Control in its maximum (clockwise) position.

1. Initially, turn the amplifier's LEVEL control to the minimum (clockwise) position.
2. Reconnect the (-) negative lead to your vehicle's battery. Apply power to the audio system and play a favorite music track.
3. Increase the source unit's volume control to the maximum listening position. Slowly turn the amplifier's LEVEL control counterclockwise and observe the I/OPT and E/OPT LEDs (on the amplifier's top).
 - In the bridged or 2-channel mode, at the ideal setting, the E/OPT LED should flash on musical peaks to indicate the amplifier is producing maximum voltage. If the I/OPT LED flashes in bridged mode, this indicates the speaker system's impedance is lower than 2 ohms and the amplifier should be configured in the parallel mode.
 - In the parallel mode, at the ideal setting, the I/OPT LED should flash on musical peaks to indicate that the amplifier is producing maximum current.

If either the I/OPT or E/OPT LED is on steadily, the amplifier is being overdriven and your speakers may be in jeopardy. Turn the LEVEL control back slightly until the I/OPT or E/OPT LED flashes on musical peaks.

SETTING PHASE

1. Initially set the PHASE control to 0°
Play a favorite audio track that has significant bass output.
2. Continue listening to the music and have another person slowly adjust the PHASE control towards 180° and back to 0° again.
3. Repeat Step 2 as needed until you find a setting that produces the most mid-bass output.

NOTE: For applications using multiple GTi amplifiers where the highest SPL is desired at a single point in the vehicle (i.e., SPL competition), adjust the PHASE controls on all amplifiers so all speakers are in phase at the microphone position. This will provide the highest SPL when measured with an SPL meter.

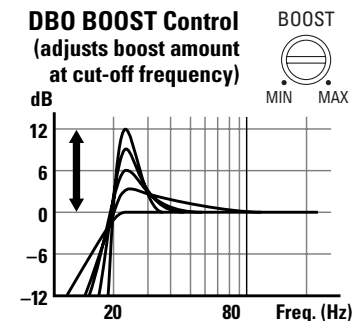
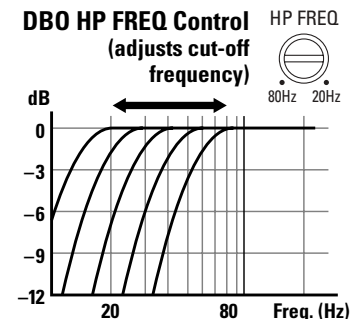

Figure 13. Frequency response curves show typical DBO control ranges for the JBL A6000GTi or A3000GTi amplifier.

SETTING DBO

DBO (or Dynamic Bass Optimizer) is a 12dB/octave high-pass filter with variable frequency (20Hz to 80Hz) and variable boost (0 to +12dB) at the cutoff frequency.

NOTE: During DBO adjustment, you can audition the effect by setting the DBO switch to OFF and then back to ON.

NOTE: The A3000GTi can be used to drive a pair of stereo mid-bass speakers. In this case, use the DBO to set the high-pass filter (from 20Hz to 80Hz) and use the crossover to set the low-pass filter (from 80Hz to 320Hz).

For a **vented box** where a subwoofer is prone to overexcursion below the tuned frequency, set DBO to ON and set the DBO HP FREQ control 10Hz below the box's resonant (tuned) frequency (e.g., 30Hz for a vented box tuned to 40Hz). Power typically wasted in this region will now be conserved and instead be available for frequencies the enclosure can reproduce. Use the DBO BOOST control to boost the bass at the set frequency by as much as 12dB, as shown in Figure 13.

For a **sealed enclosure**, use DBO to enhance the middle of the bass region. Set DBO to ON, and then set the DBO HP FREQ control to 35Hz to 40Hz. Adjust the DBO BOOST control for a big and full bass sound. Alternatively, for a tighter-sounding bass, set the DBO HP FREQ control between 45Hz to 50Hz and also adjust the DBO BOOST control according to your preference.

For an **infinite baffle** application, set DBO to ON, and then set the HP FREQ control to the speaker's Fs value (to keep the subwoofer from trying to create bass below the resonant frequency). Adjust the DBO BOOST control according to your taste.

SETTING UP THE GTi AMPLIFIER

REPLACING THE FUSE OR NEON TUBES

The JBL A6000/A3000GTi amplifier is equipped with an internal fuse, a 20-inch neon tube and two 6-inch neon tubes. Should the fuse or a neon tube fail, perform the following steps to replace the part:

NOTE: For neon tube replacement, see your authorized JBL car audio dealer to purchase new StreetGlow® neon tubes in 6- or 20-inch sizes.

NOTE: Although the following steps discuss and illustrate how to disassemble a JBL A6000GTi, the disassembly procedure for a JBL A3000GTi is similar.

1. Disconnect and unmount the amplifier from the vehicle. On a soft surface, turn the amplifier over to view the bottom. Using a T-25 screwdriver, remove the four large Torx-head screws along the bottom edges and set them aside (see Figure 14).
2. Turn the amplifier over to view the top. Using a 5/32-inch Allen wrench, remove the four cap screws on the clear cover and set them aside (see Figure 14).
3. Slide the clear cover off and set it aside (see Figure 14).

Figure 14. Removing bottom screws and the clear cover from the A6000GTi amplifier. NOTE: Do not remove the logo badge assembly.

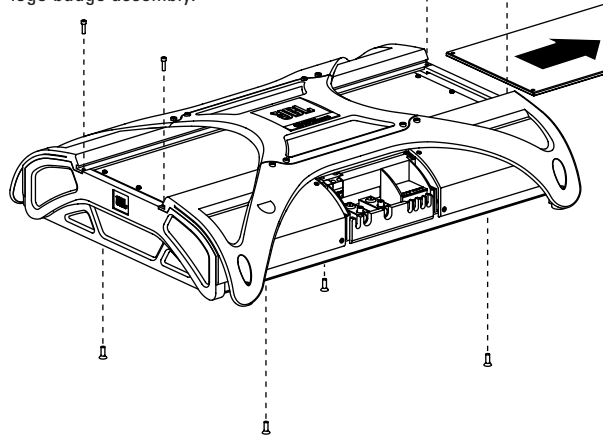

4. Using a T-15 screwdriver, remove the four Torx-head screws around the output panel and set them aside (see Figure 15).
5. Repeat Step 4 for the input panel (see Figure 15).
6. Remove the cover and set it aside (see Figure 15).

Figure 15. Removing the input and output screws and the cover from the A6000GTi amplifier.

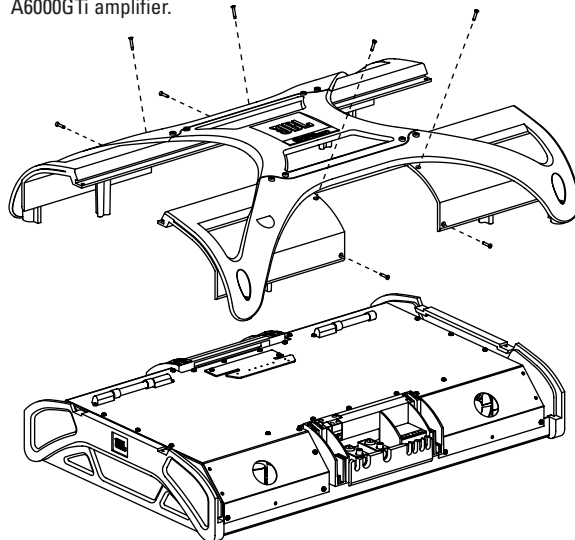

SETTING UP THE GTi AMPLIFIER

- Using a T-15 screwdriver, remove the two Torx-head screws on the display board and set them aside (see Figure 16 below). Disconnect the ribbon cable from display board.
- Using a T-15 screwdriver, remove the 16 Torx-head screws on the perforated shield and set them aside (see Figure 16).

Figure 16. Removing the fuse from the A6000GTi amplifier.

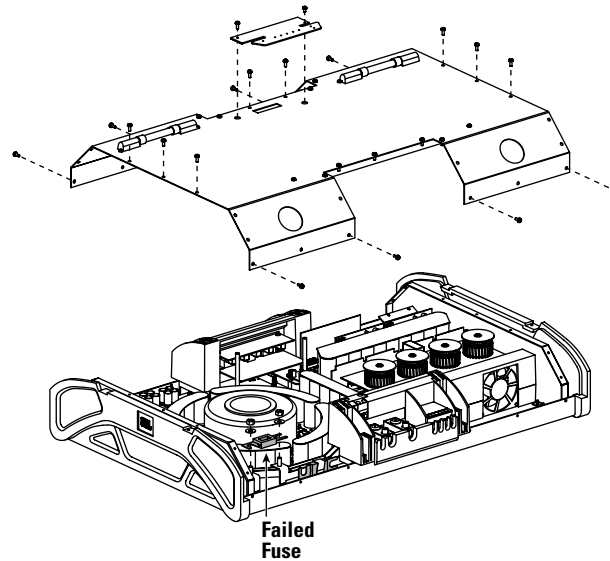

- Using a small flat-blade screwdriver, disconnect the wiring for the neon tubes.
- Remove the perforated shield and set it aside.
- Replace the fuse or a neon tube as follows:
 - To replace the fuse on the amplifier circuit board (see Figure 16), use a 7/16-inch hex-socket driver to remove the two fuse nuts and then discard the failed fuse. Fasten the replacement fuse in place using the two fuse nuts.
 - To replace a neon tube (see Figure 17), use a T-15 screwdriver and pliers to remove the two Torx-head screws, nuts and washers on the two clamps that hold each neon tube in place. Remove the failed neon tube and unscrew its wires.

On the replacement neon tube, clip off the cigarette lighter adapter. Then strip the wires and screw the ends to the connector. Refasten the two clamps with hardware in place around the neon tube. If needed, repeat this procedure for another failed neon tube.

Figure 17. Neon tube locations on the A6000GTi amplifier.

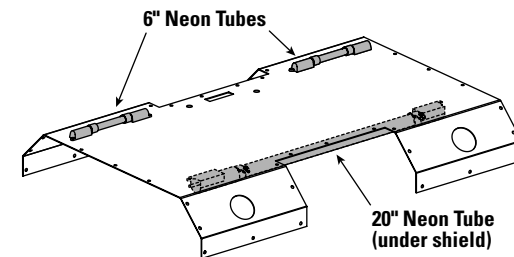

- Reassemble the amplifier in reverse order, as discussed in Steps 1 through 10.

TROUBLESHOOTING

SYMPTOM	LIKELY CAUSE	SOLUTION
No audio (Power LED is off)	No voltage at power or remote terminal	Check BATT+, REMOTE and GND – terminals with VOM for blown fuse or poor connection
	Internal fuse blown (incorrect power connections)	Replace internal fuse (see Replacing the Fuse or Neon Tubes section)
No audio (Power LED is flashing)	Low or high voltage at power terminal	Check BATT+ terminal with VOM for voltage between 10 and 16 Vdc; if not within limits, check vehicle's electrical system
No audio (Power and Fault LEDs are on)	Direct current on speaker output(s)	Disconnect cable from REMOTE terminal; if Fault LED is still on, contact local JBL service center
No audio (Power and Thermal LEDs are on)	Internal amplifier temperature is over 85° C	Check for blocked vents or whether the ambient temperature is above 85° C
Distorted audio (I OPT and/or E OPT LED[s] are on more than off)	Amplifier's gain is set to High	Properly adjust the LEVEL control (see Setting Input Sensitivity section)
Distorted audio (I OPT and/or E OPT LED[s] work correctly)	Defective source unit	Try new source unit
	Shorted speaker wires	Disconnect wires from SPEAKER OUTPUTS and check for shorts between wires, or between a wire and the vehicle's chassis
Music lacks "punch"	Speakers are out of phase	Check speaker connections (see sections on speaker connections)
	Wrong output mode	Verify output mode setting (see Making the Connections section)
Neon tubes do not light	No voltage to neon tubes for +12 Vdc	Check LIGHTING terminal with VOM
	Neon tubes are dead	Replace neon tubes (see Replacing the Fuse or Neon Tubes section)

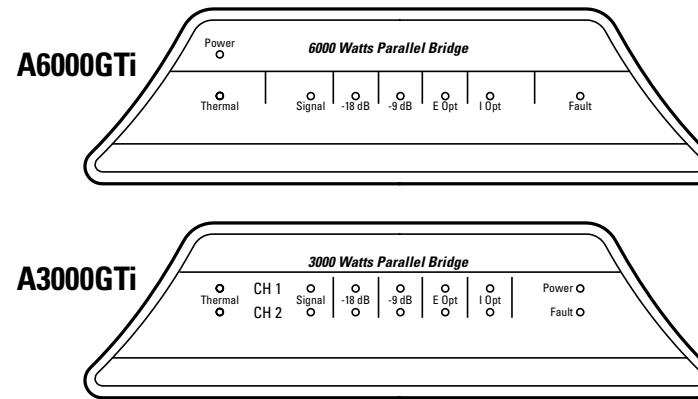

Figure 18. Display indicates Power Output and Protection status.

Declaration of Conformity



We, Harman Consumer International
2, route de Tours
72500 Chateau-du-Loir
France

declare in own responsibility that the products
described in this owner's manual are in compliance
with technical standards:

EN 55013:2001
EN 55020:2002

A handwritten signature in black ink, appearing to read 'Emmanuel Millot'.

Emmanuel Millot
Harman Consumer International
Chateau-du-Loir, France 11/03

JBL Consumer Products
250 Crossways Park Drive, Woodbury, NY 11797 USA
© 2003 Harman International Industries, Incorporated

JBL and Crown are registered trademarks of
Harman International Industries, Incorporated.

Part No. GTiAMPOM11/03

H A Harman International Company

The JBL logo is the letters 'JBL' in a bold, black, sans-serif font, enclosed within a white square.

www.jbl.com